











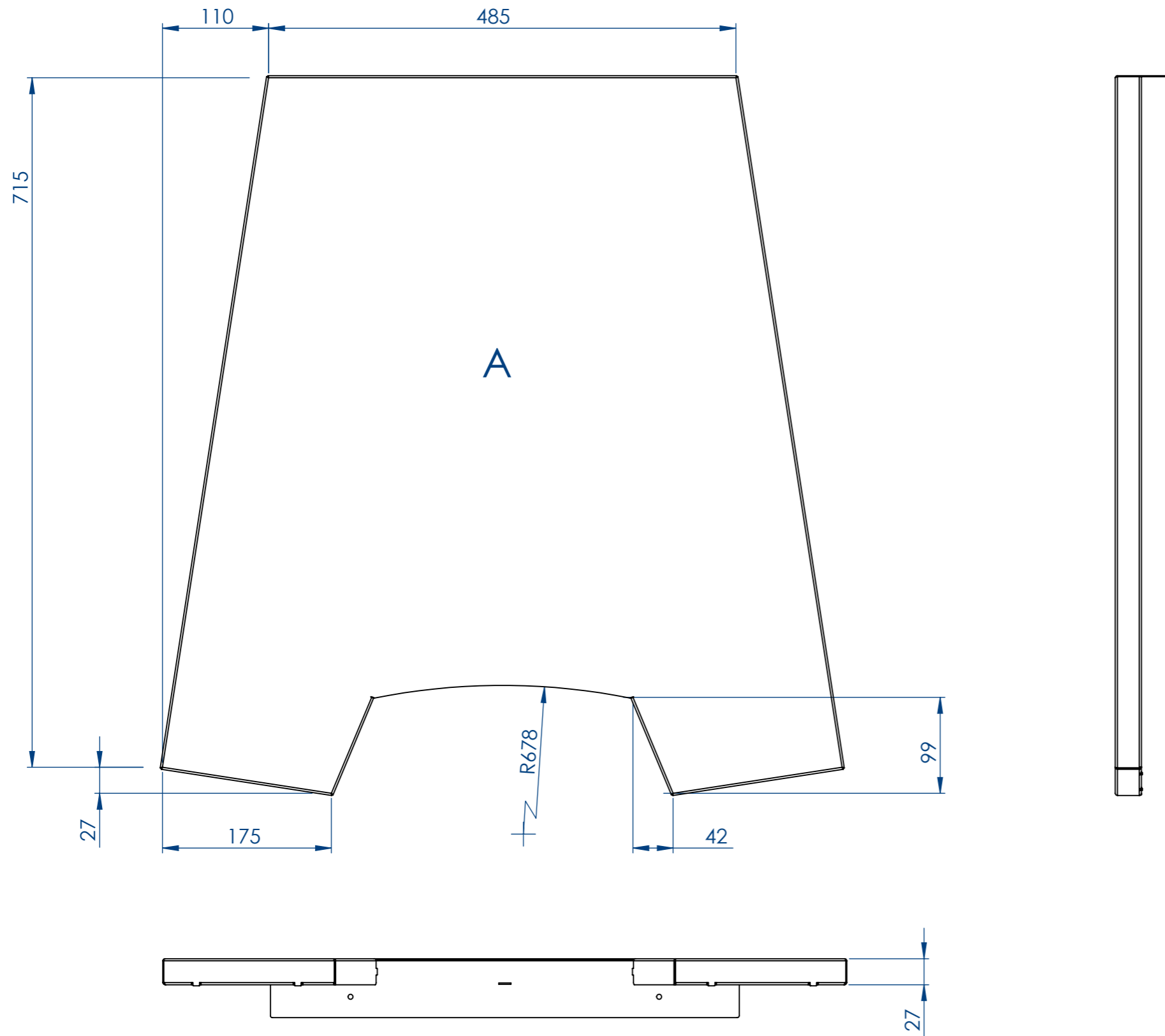

Drawn by	Drawing according to ISO 1101, ISO 406, NEN 3634			Dim. ISO 2768-M, unless specified otherwise		ISO-5457
Material	See Bill Of Materials	Unit	mm	Linear dimensions	Angular dimensions	A3
Colour		Dims		2000-4000 ±2	< -10 ±1°	
Remark		Date		1000-2000 ±1.2	10-50 ±0°30'	Scale 1:20
			Project	400-1000 ±0.8	50-120 ±0°20'	
				120-400 ±0.5	120-400 ±0°10'	Item Number X-PROTINT
				30-120 ±0.3	400-> ±0°5'	
				6-30 ±0.2	Charter dimensions	
				3-6 ±0.1	0.5-3 ±0.2	
				0.5-3 ±0.1	3-6 ±0.5	
					6-> ±1	
 THE NETHERLANDS P.O. Box 220 - 2170 AE Sassenheim Tel. +31(0)252 240 800 www.fast-fluid.com CONFIDENTIAL PROPRIETARY MATERIAL: All design, reproduction, manufacturing, use & sales rights of items shown here on or of articles fabricated therefrom are expressly reserved by FAST & FLUID © 2015.			 			
 NETHERLANDS		Assembly Part number	Description			
			Sticker dimensions			



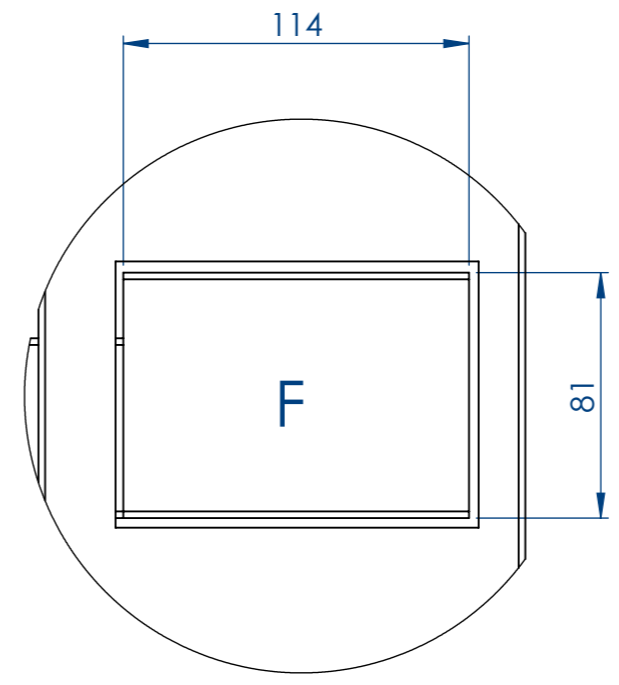
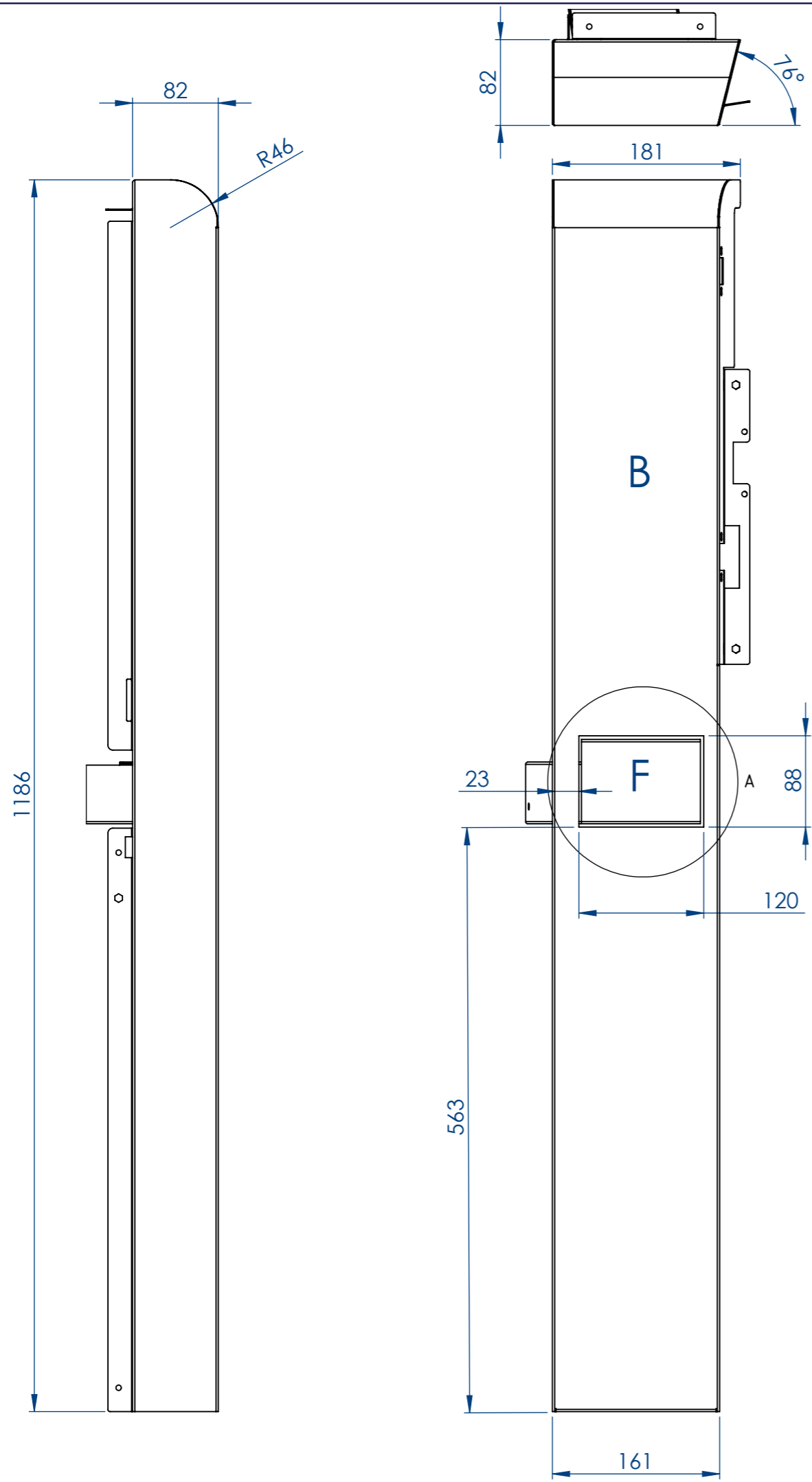



Drawn by	Drawing according to ISO 1101, ISO 406, NEN 3634			Dim. ISO 2768-M, unless specified otherwise		ISO-5457
Material	See Bill Of Materials	Unit	mm	Linear dimensions	Angular dimensions	A3
Colour		Dims		2000-4000 ±2	< -10 ±1°	
Remark		Date		1000-2000 ±1.2	10-50 ±0°30'	Scale 1:20
			Project	400-1000 ±0.8	50-120 ±0°20'	
				120-400 ±0.5	120-400 ±0°10'	Item Number X-PROTINT
				30-120 ±0.3	400-> ±0°5'	
				6-30 ±0.2	Charter dimensions	
				3-6 ±0.1	0.5-3 ±0.2	
				0.5-3 ±0.1	3-6 ±0.5	
					6-> ±1	
 THE NETHERLANDS P.O. Box 220 - 2170 AE Sassenheim Tel. +31(0)252 240 800 www.fast-fluid.com CONFIDENTIAL PROPRIETARY MATERIAL: All design, reproduction, manufacturing, use & sales rights of items shown here on or of articles fabricated therefrom are expressly reserved by FAST & FLUID © 2015.			 			
Assembly Part number		Description				
NETHERLANDS		Sticker dimensions				



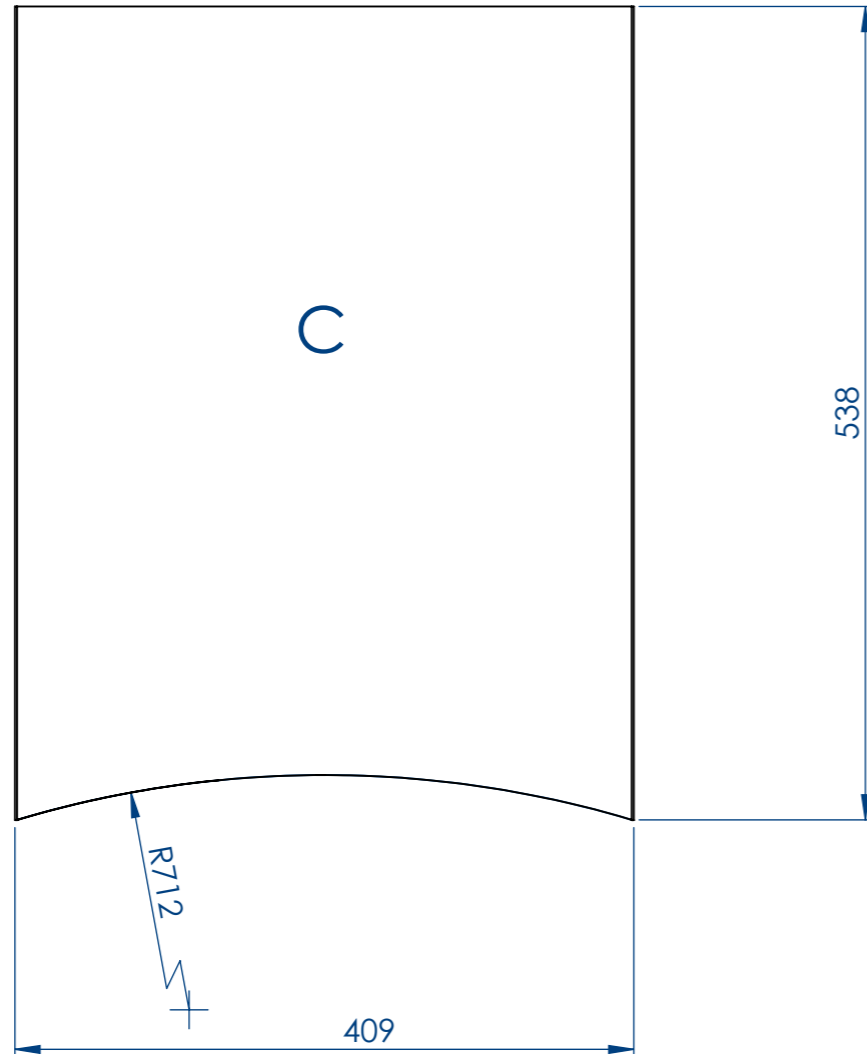
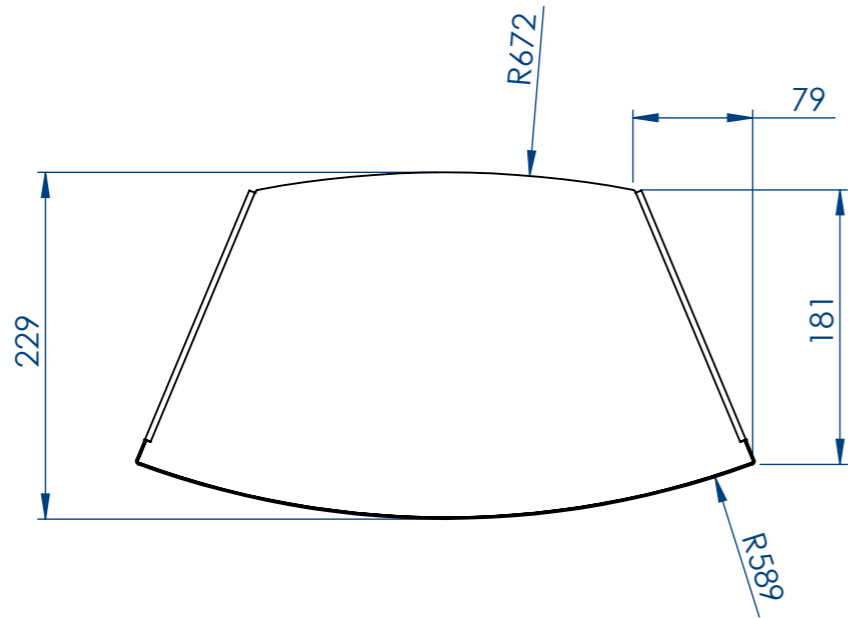



DETAIL A
SCALE 2 : 5

Drawn by	Drawing according to ISO 1101, ISO 406, NEN 3634			Dim. ISO 2768-M, unless specified otherwise		ISO-5457
Material	See Bill Of Materials	Unit	mm	Linear dimensions	Angular dimensions	A3
Colour		Dims		2000-4000 ±2	< -10 ±1°	
Remark		Date		1000-2000 ±1.2	10-50 ±0°30'	Scale 1:10
 THE NETHERLANDS P.O. Box 220 - 2170 AE Sassenheim Tel. +31(0)252 240 800 www.fast-fluid.com CONFIDENTIAL PROPRIETARY MATERIAL: All design, reproduction, manufacturing, use & sales rights of items shown here on or of articles fabricated therefrom are expressly reserved by FAST & FLUID © 2015.			 			
Assembly Part number		Description		Chamfer dimensions		Item Number X-PROTINT
NETHERLANDS		Sticker dimensions		6-30 ±0.3	0.5-3 ±0.2	
				3-6 ±0.1	3-6 ±0.5	
				0.5-3 ±0.1	6-> ±1	

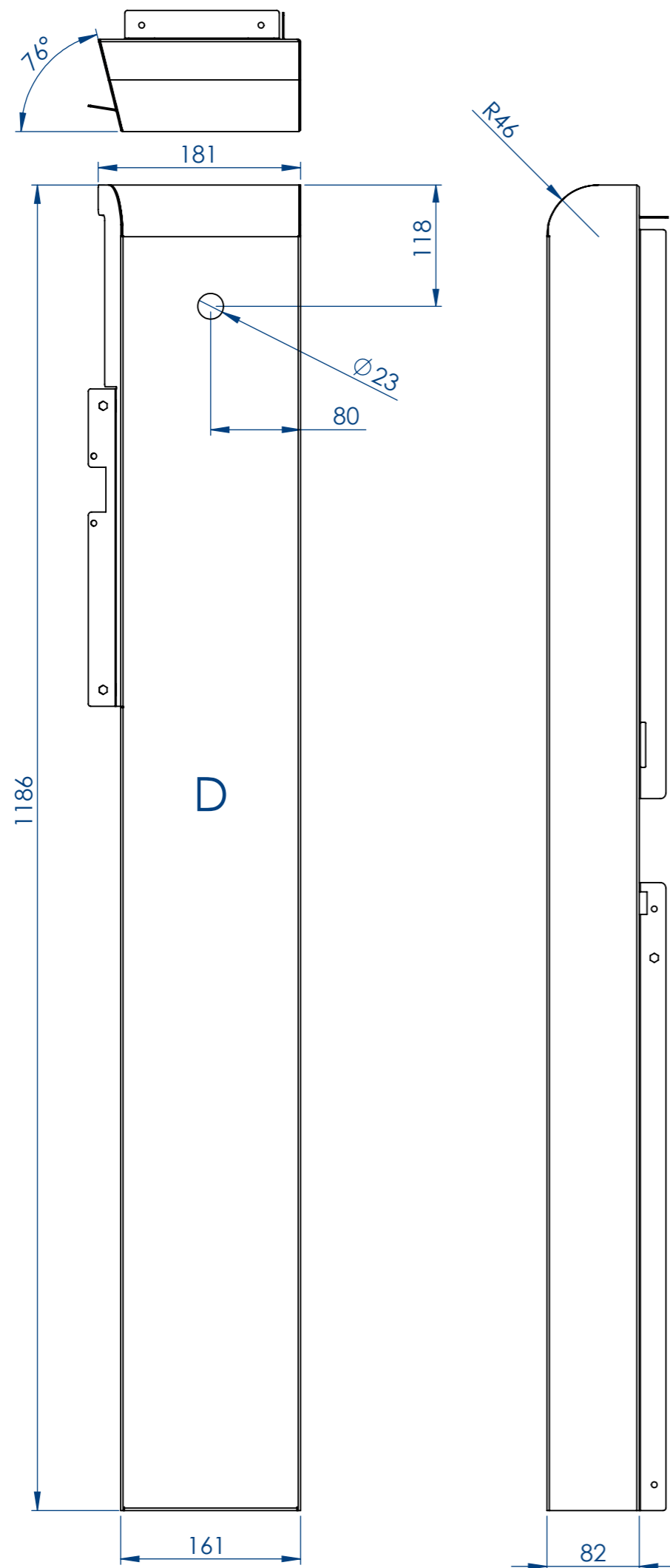





Drawn by	Drawing according to ISO 1101, ISO 406, NEN 3634			Dim. ISO 2768-M, unless specified otherwise		ISO-5457
Material	See Bill Of Materials	Unit	mm	Linear dimensions	Angular dimensions	A3
Colour		Dims		2000-4000 ±2	< -10 ±1°	
Remark		Date		1000-2000 ±1.2	10-50 ±0°30'	
			Project	400-1000 ±0.8	50-120 ±0°20'	
				120-400 ±0.5	120-400 ±0°10'	Scale 1:20
				30-120 ±0.3	400-> ±0°5'	
				6-30 ±0.2	Chamfer dimensions	
				3-6 ±0.1	0.5-3 ±0.2	
				0.5-3 ±0.1	3-6 ±0.5	
					6-> ±1	
 THE NETHERLANDS P.O. Box 220 - 2170 AE Sassenheim Tel. +31(0)252 240 800 www.fast-fluid.com CONFIDENTIAL PROPRIETARY MATERIAL: All design, reproduction, manufacturing, use & sales rights of items shown here on or of articles fabricated therefrom are expressly reserved by FAST & FLUID © 2015.				 		Item Number
 HELDING COMPANY NETHERLANDS		Assembly Part number	Description	Sticker dimensions		X-PROTINT

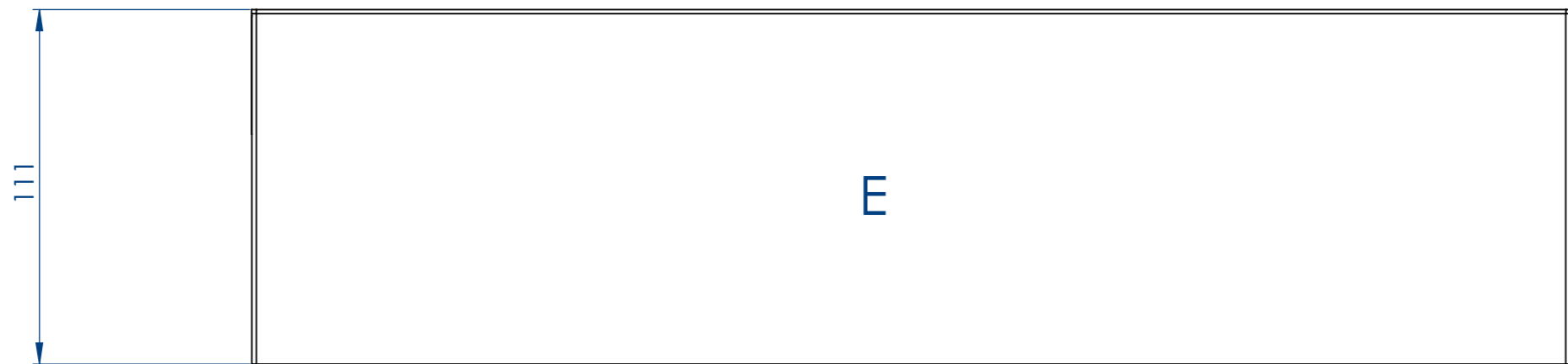
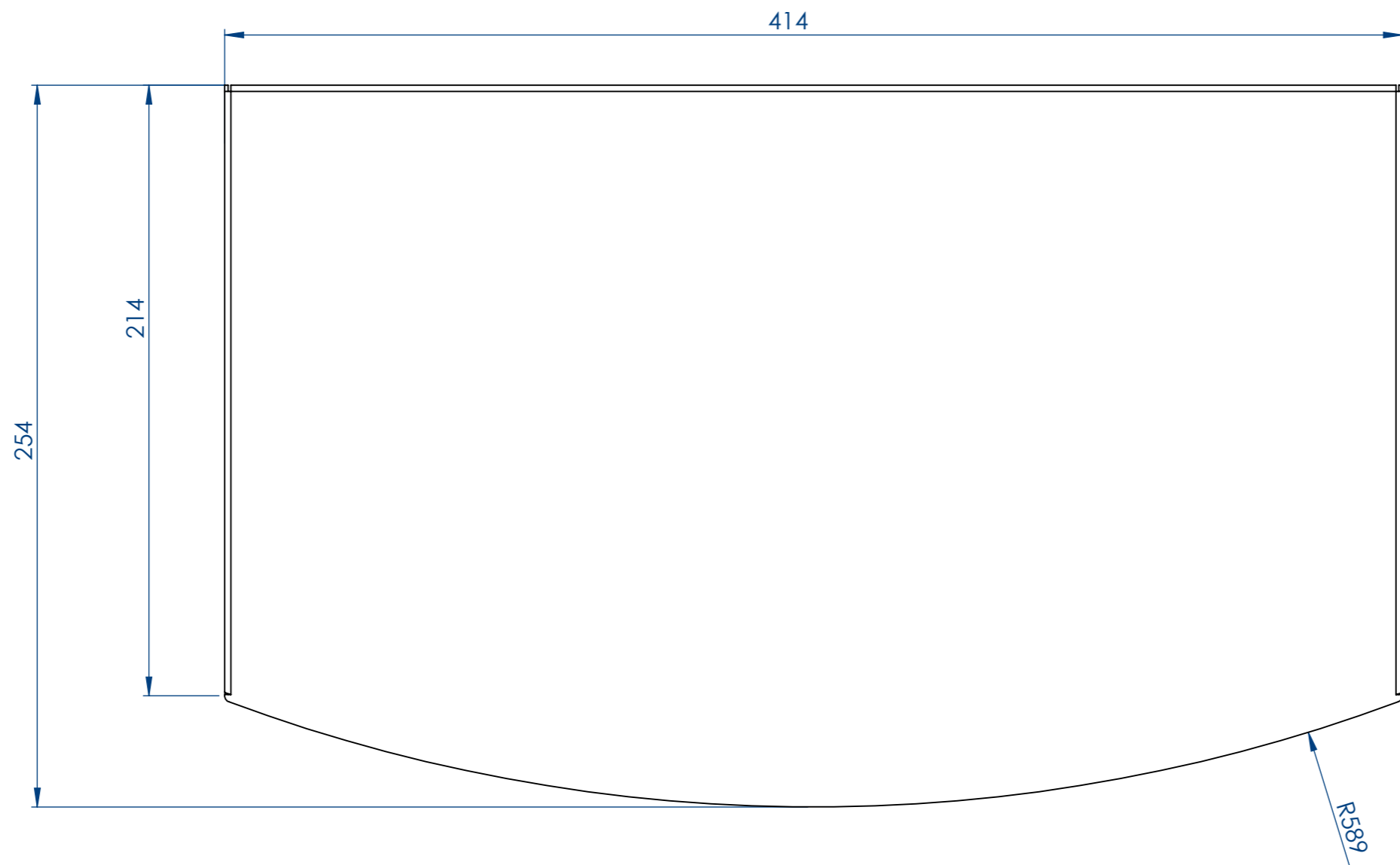

Drawn by	Drawing according to ISO 1101, ISO 406, NEN 3634			Dim. ISO 2768-M, unless specified otherwise		ISO-5457
Material	See Bill Of Materials	Unit	mm	Linear dimensions	Angular dimensions	A3
Colour		Dims		2000-4000 ±2	< -10 ±1°	
Remark		Date		1000-2000 ±1.2	10-50 ±0°30'	Scale 1:20
			Project	400-1000 ±0.8	50-120 ±0°20'	
				120-400 ±0.5	120-400 ±0°10'	Item Number X-PROTINT
				30-120 ±0.3	400-> ±0°5'	
				6-30 ±0.2	Charter dimensions	
				3-6 ±0.1	0.5-3 ±0.2	
				0.5-3 ±0.1	3-6 ±0.5	
					6-> ±1	
 THE NETHERLANDS P.O. Box 220 - 2170 AE Sassenheim Tel. +31(0)252 240 800 www.fast-fluid.com CONFIDENTIAL PROPRIETARY MATERIAL: All design, reproduction, manufacturing, use & sales rights of items shown here on or of articles fabricated therefrom are expressly reserved by FAST & FLUID © 2015.			 			
 HELDING COMPANY NETHERLANDS		Assembly Part number	Description	Sticker dimensions		



Drawn by	Drawing according to ISO 1101, ISO 406, NEN 3634			Dim. ISO 2768-M, unless specified otherwise		ISO-5457
Material	See Bill Of Materials	Unit	mm	Linear dimensions	Angular dimensions	A3
Colour		Dims		2000-4000 ±2	< -10 ±1°	
Remark		Date		1000-2000 ±1.2	10-50 ±0°30'	Scale 1:20
			Project	400-1000 ±0.8	50-120 ±0°20'	
				120-400 ±0.5	120-400 ±0°10'	Item Number X-PROTINT
				30-120 ±0.3	400-> ±0°5'	
				6-30 ±0.2	Charter dimensions	
				3-6 ±0.1	0.5-3 ±0.2	
				0.5-3 ±0.1	3-6 ±0.5	
					6-> ±1	
 THE NETHERLANDS P.O. Box 220 - 2170 AE Sassenheim Tel. +31(0)252 240 800 www.fast-fluid.com CONFIDENTIAL PROPRIETARY MATERIAL: All design, reproduction, manufacturing, use & sales rights of items shown here on or of articles fabricated therefrom are expressly reserved by FAST & FLUID © 2015.			 			
 HELDING COMPANY NETHERLANDS		Assembly Part number	Description			
			Sticker dimensions			